



- Classic Collection (CS-10)**
- Powder Coated Black
 - Ductile Iron
 - 6 Feet Long
 - Surface Mount

Benches - Backed



Classic Collection (CR-298)

- Powder Coated Black
- Ductile Iron
- 6 Feet Long
- Surface Mount



Benches - Backless

Auburn Streetscape - 60% Progress Meeting

May 11, 2017

© 2017 JPR - All Rights Reserved



JONES PETRIE RAFINSKI
your one single source

Surveying • Engineering • Planning • Architecture • Utility Management
GIS • Environmental • Renewable Energy • Landscape Architecture

BIKE RACK PROVIDED BY ROTARY CLUB

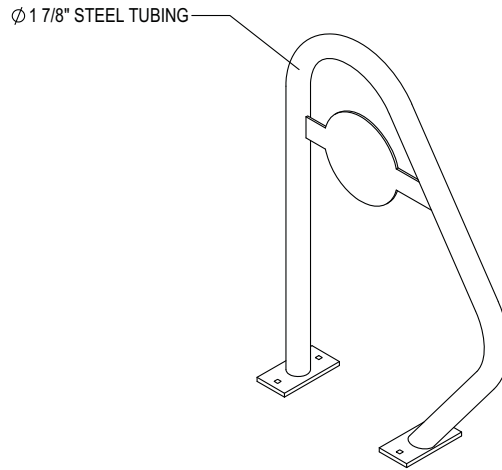
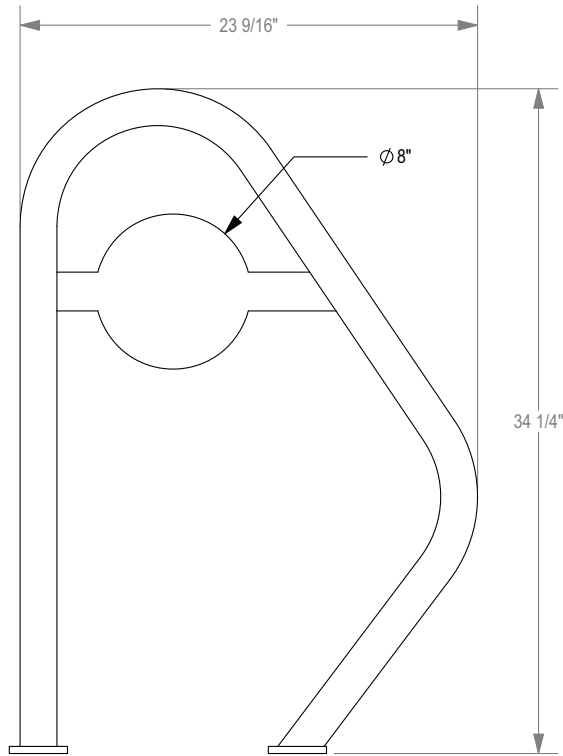

CHECK DESIRED MOUNT □

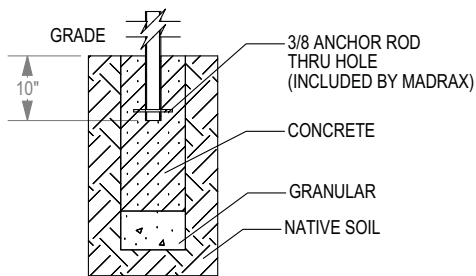

□ IN GROUND MOUNT (IG)

SECTION VIEWS

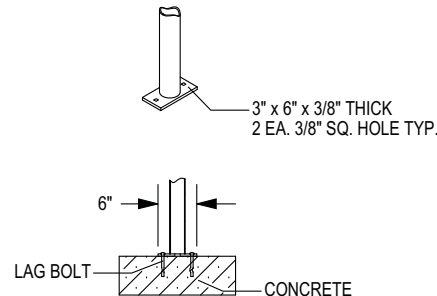

□ SURFACE FLANGE MOUNT (SF)

Madrax Phoenix Bike Rack

- PHX-SNG-ROTARY
- Powder Coated Steel
- Includes Decal
- Height: 34.25 in.

Bike Racks

Auburn Streetscape- 60% Progress Meeting

May 11 2017

© 2017 JPR - All Rights Reserved



JONES PETRIE RAFINSKI
your one single source

Surveying • Engineering • Planning • Architecture • Utility Management
GIS • Environmental • Renewable Energy • Landscape Architecture

KEYSTONE RIDGE

The **HARBOR STRAIGHT BOLLARD** adds a subtle design touch to public space management, providing security as a vehicle deterrent. Add chain loops to direct the flow of pedestrian traffic or swap in larger loops for bicycle mountings.



STANDARD FEATURES

- Color: exclusive KEYSHIELD® polyester powder coating finish
- Support: permanent or removable
- Top: rounded or angled
- Fully assembled unit
- Continuous weld seams
- Three-year warranty
- Made in the USA

CUSTOM OPTIONS

- Color: custom KEYSHIELD® powder coat
- Support: surface mount

ENHANCEMENTS

- Inquire about coordinating benches, litter receptacles, planters, tables, and other furnishings
- Cast bronze plaques



Harbor Straight Bollard

- Powder Coated Black
- Angled Top
- Weight: 100 lbs.
- Height: 37 in.

Bollards

STERNBERG VINTAGE LIGHTING (E460LED-FA-PT-BC-21L45-T5-MDLI4-BKT)



Accessory Options:

- Banner arms
- Electrical outlet
- Flag pole holder
- Hanging flower baskets
- Speaker hub
- Wreath hook

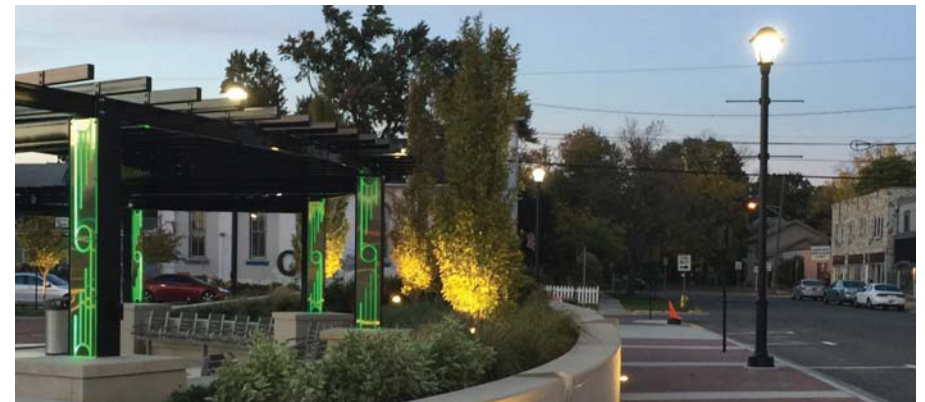

Lighting

Auburn Streetscape- 60% Progress Meeting

May 11 2017

© 2017 JPR - All Rights Reserved



JONES PETRIE RAFINSKI
your one single source

Surveying • Engineering • Planning • Architecture • Utility Management
GIS • Environmental • Renewable Energy • Landscape Architecture

SIGN POST



ACP SIGN POST



STANDARD SIGN POST

UNILOCK PAVERS



UNILOCK HOLLANDSTONE



UNILOCK HOLLANDSTONE



RUSTIC RED (ENDURACOLOR FINISH)

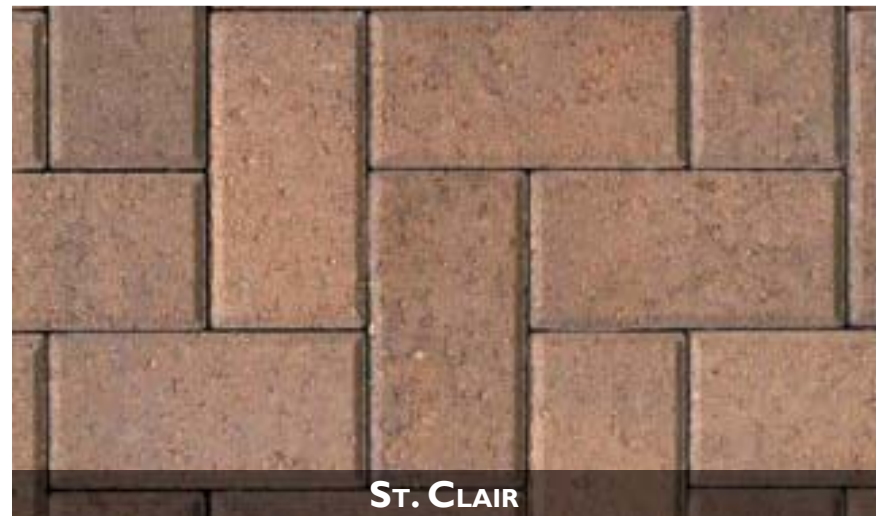

ST. CLAIR

Pavers

Auburn Streetscape- 60% Progress Meeting

May 11 2017

© 2017 JPR - All Rights Reserved



JONES PETRIE RAFINSKI
your one single source

Surveying • Engineering • Planning • Architecture • Utility Management
GIS • Environmental • Renewable Energy • Landscape Architecture



Trash Receptacle

Auburn Streetscape - 60% Progress Meeting

May 11, 2017

© 2017 JPR - All Rights Reserved



JONES PETRIE RAFINSKI
your one single source
Surveying • Engineering • Planning • Architecture • Utility Management
GIS • Environmental • Renewable Energy • Landscape Architecture



Tree Grate

- 5' x 5'
- Powder Coated Black

Tree Grate

Auburn Streetscape- 60% Progress Meeting

May 11 2017

© 2017 JPR - All Rights Reserved



JONES PETRIE RAFINSKI
your one single source
Surveying • Engineering • Planning • Architecture • Utility Management
GIS • Environmental • Renewable Energy • Landscape Architecture

CONCRETE CURBED PLANTER IDEAS



Planter Ideas

Auburn Streetscape - 60% Progress Meeting

May 11, 2017

© 2017 JPR - All Rights Reserved



JONES PETRIE RAFINSKI
your one single source
Surveying • Engineering • Planning • Architecture • Utility Management
GIS • Environmental • Renewable Energy • Landscape Architecture

ZELKOVA



IVORY SILK LILAC TREE



Trees

Auburn Streetscape- 60% Progress Meeting

May 11 2017

© 2017 JPR - All Rights Reserved



JONES PETRIE RAFINSKI
your one single source

Surveying • Engineering • Planning • Architecture • Utility Management
GIS • Environmental • Renewable Energy • Landscape Architecture

SHRUBS



GRASSES



PERENNIALS



Shrubs, Grasses, Perennials

Auburn Streetscape - 60% Progress Meeting

May 11, 2017

© 2017 JPR - All Rights Reserved



JONES PETRIE RAFINSKI
your one single source

Surveying • Engineering • Planning • Architecture • Utility Management
GIS • Environmental • Renewable Energy • Landscape Architecture

MAD ANTHONY DUMPSTER ENCLOSURE RENDERING

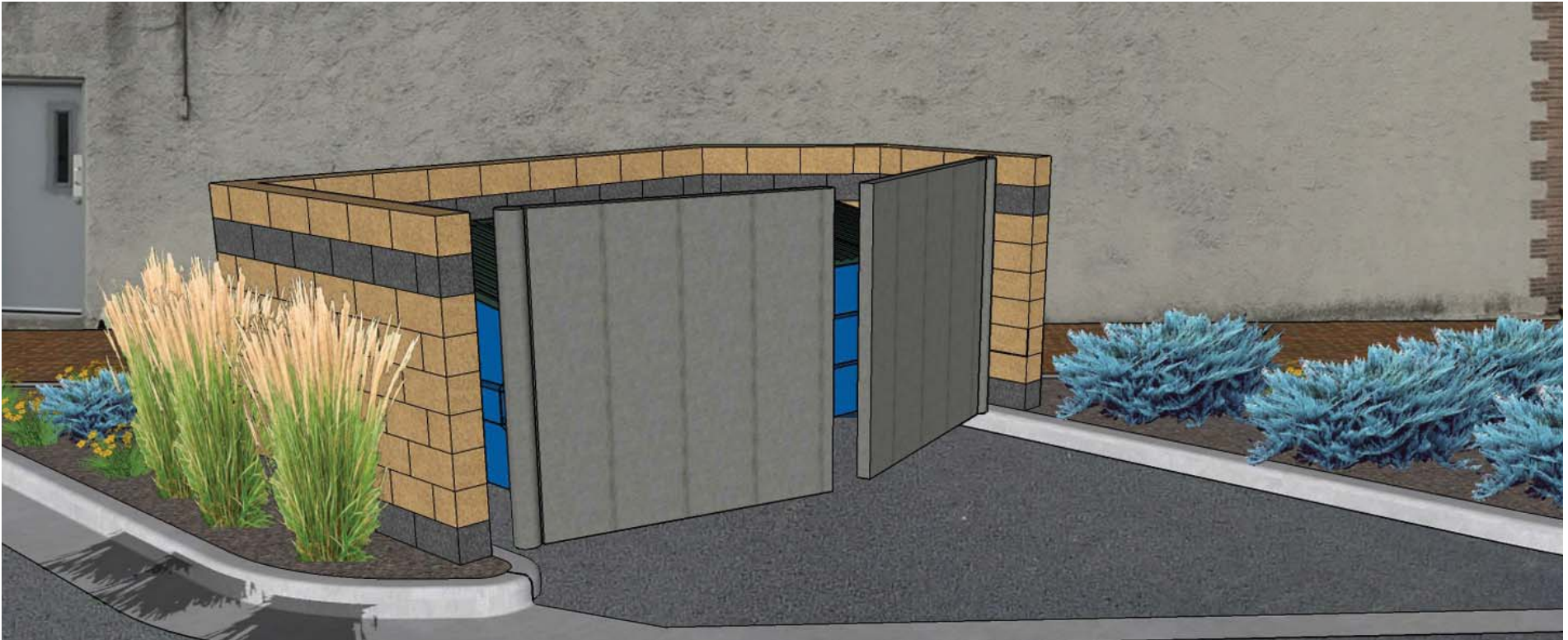

Dumpster Enclosure

- 6' Tall Wall
- Split Face Block Wall (See Above)
- SimTek Vinyl Fence (See Left)



Dumpster Enclosure

Auburn Streetscape- 60% Progress Meeting

May 11 2017

© 2017 JPR - All Rights Reserved



JONES PETRIE RAFINSKI
your one single source

Surveying • Engineering • Planning • Architecture • Utility Management
GIS • Environmental • Renewable Energy • Landscape Architecture

EXISTING HISTORICAL PLAQUE

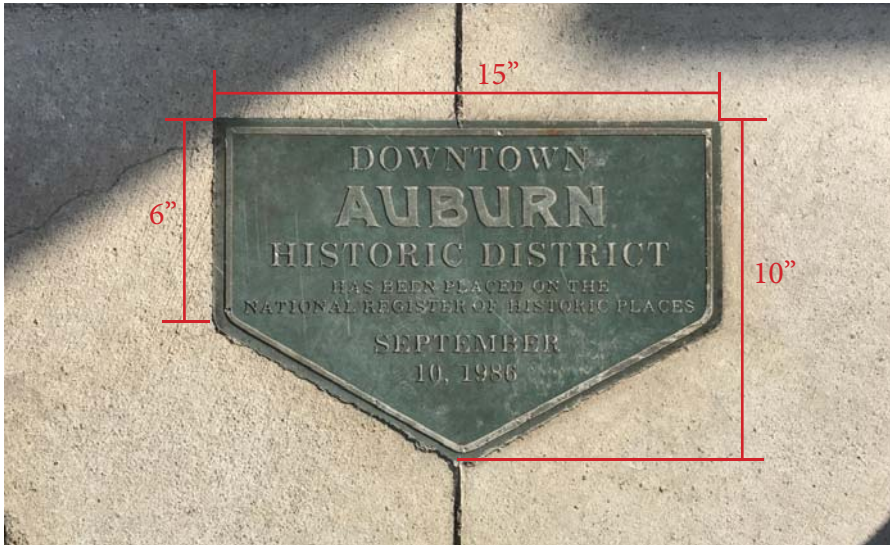

CONCEPTUAL RENDERINGS

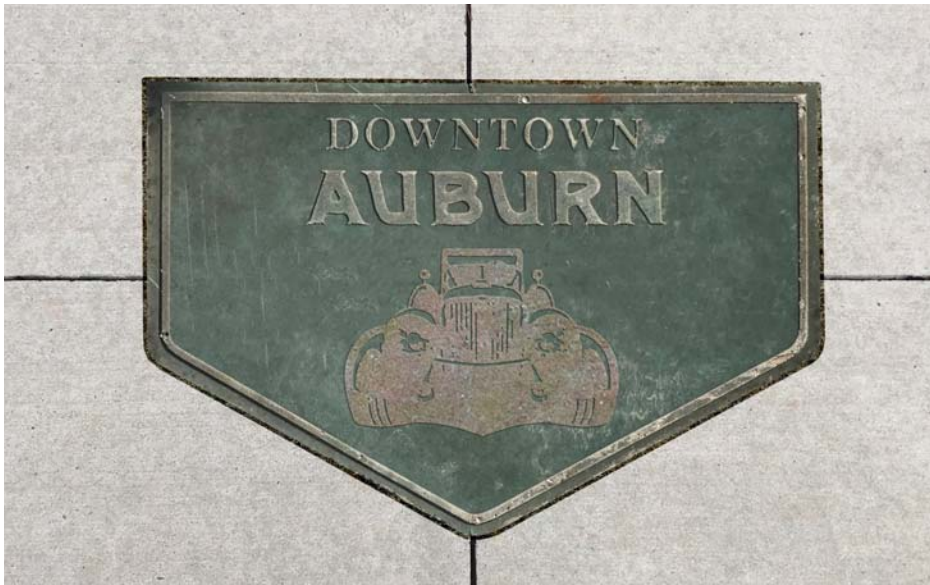
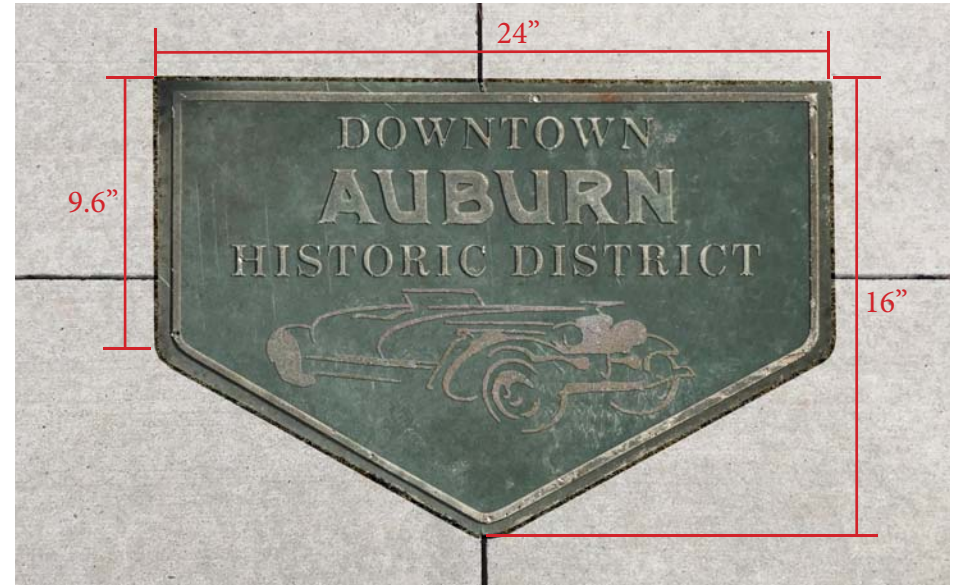

Historical Plaque Concepts

Auburn Streetscape - 60% Progress Meeting

May 11, 2017

© 2017 JPR - All Rights Reserved



JONES PETRIE RAFINSKI
your one single source
Surveying • Engineering • Planning • Architecture • Utility Management
GIS • Environmental • Renewable Energy • Landscape Architecture

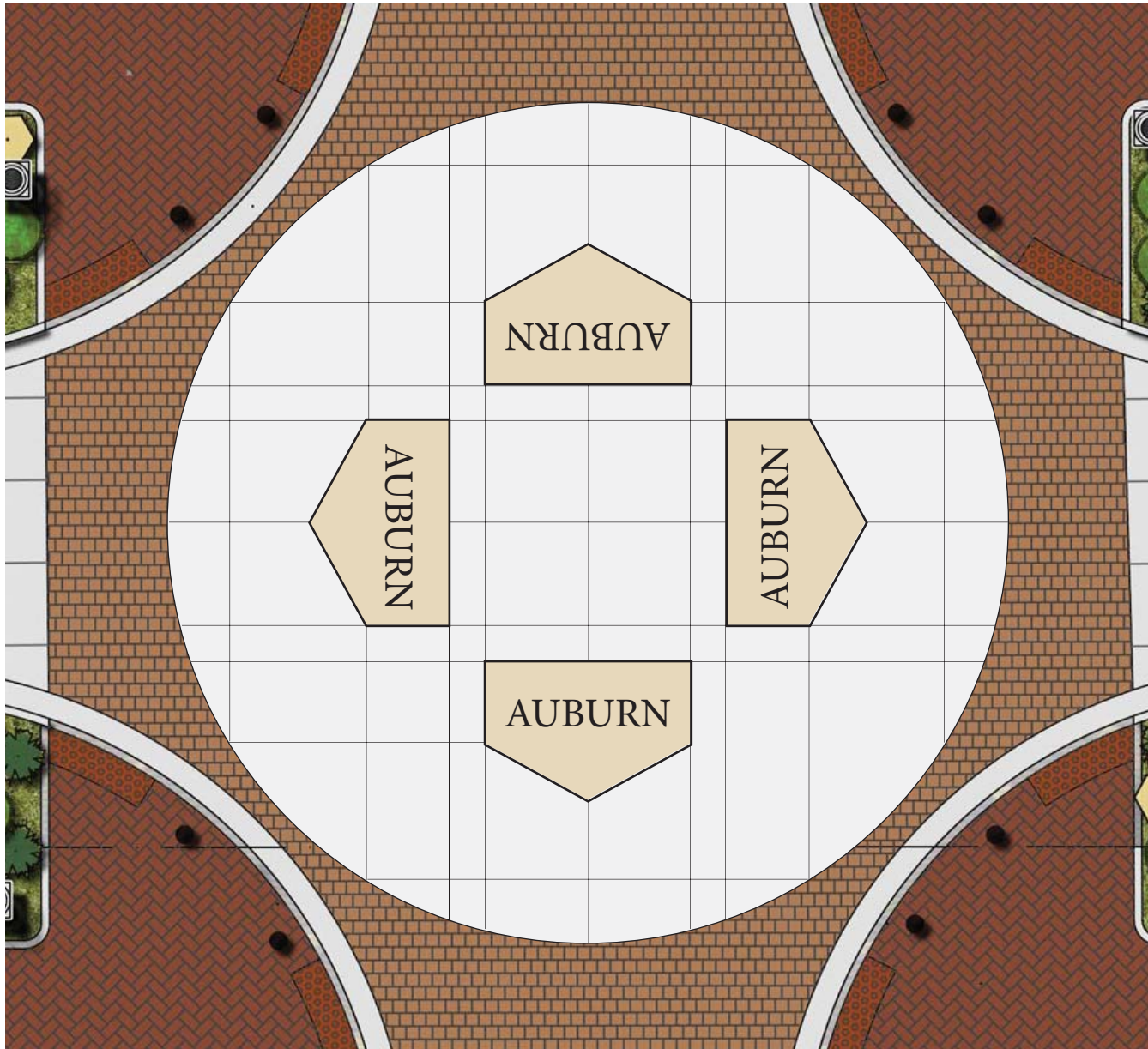

Center Circle Concept

Auburn Streetscape- 60% Progress Meeting

May 11 2017

© 2017 JPR - All Rights Reserved



JONES PETRIE RAFINSKI
your one single source
Surveying • Engineering • Planning • Architecture • Utility Management
GIS • Environmental • Renewable Energy • Landscape Architecture